



TANDBERG

Instruction Manual Series 6000 X

Contents:

Tapes	5
Power supply	5
Vertical installation	5
Preparation for use	6
Inputs and outputs	6
Stereo receiver or amplifier	6
Headphones	6
Copying tapes	7
Record player	7
Centre channel	7
Microphone	8
Mono recording	8
Mono playback	8
Mono recording	9
Stereo recording	9
Programme monitoring during recording ..	10
Mono playback	11
Stereo playback	11
Use as pre-amplifier	12
Sound-on-sound	12
Add-a-track	14
Echo effect	14
Mixing	16
Level limiter	16
Sound-on-sound switch	17
FM-MX filter	18
Monitoring during fast wind or rewind- cueing	18
4-track recording and playback	19
Automatic stop	19
Programme editing	20
Tape splicing	20
Electrical remote control of start and stop	21
Erasing	21
Cleaning heads and tape path	21
Case	22
Microphone TM 5	22
Connecting plugs	23
Function table	24
Block diagram	25
Technical specifications	26



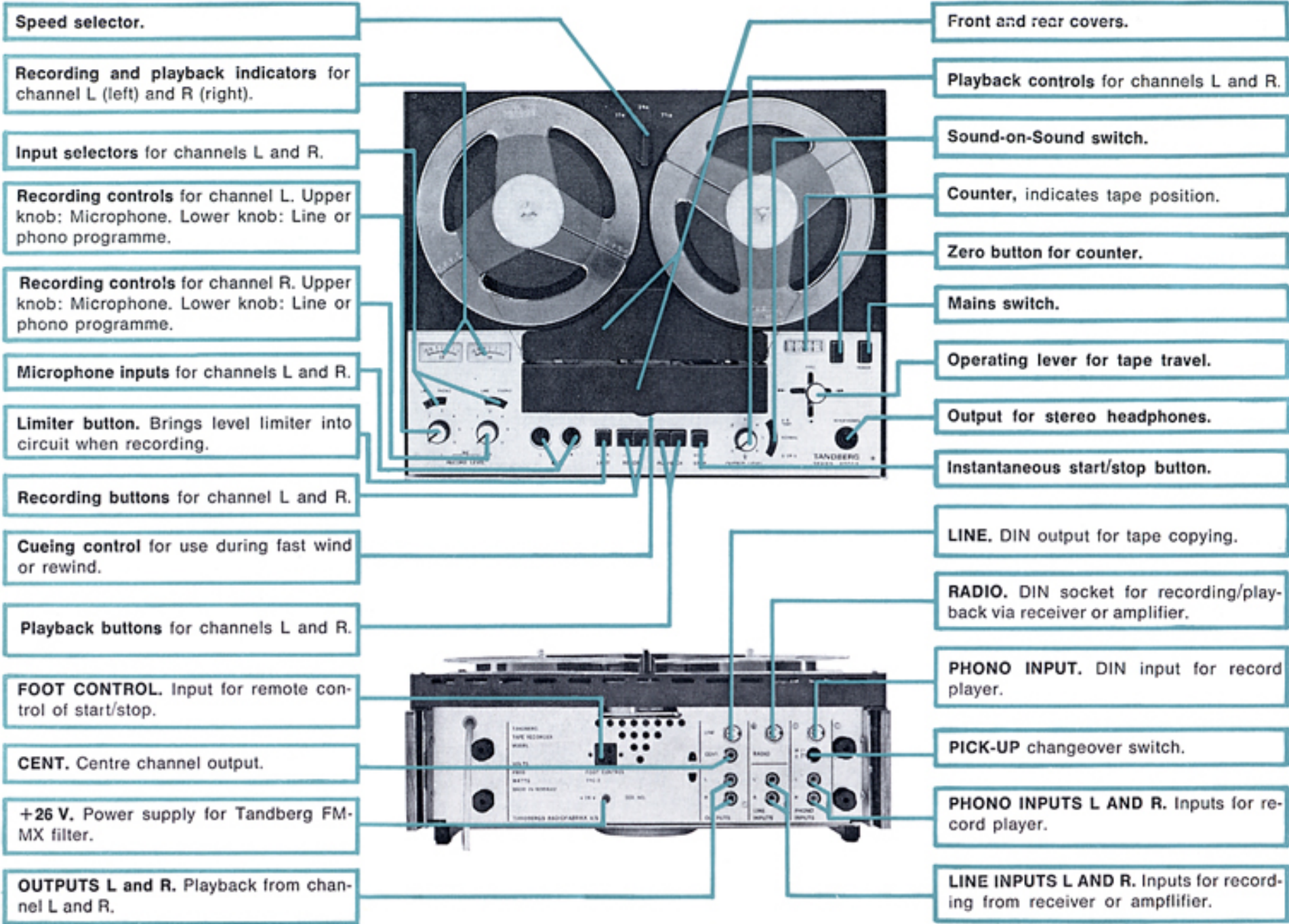

Tapes

Tandberg tape recorder 6000 X is designed for Low Noise Tape, which provides an extremely good signal/noise ratio. If conventional tapes are used, music will not

be heard to the best advantage, since the highest frequencies will be attenuated. Low Noise Tapes are therefore recommended for recording.

Power supply

This tape recorder is designed for 230 V/50 Hz mains operation. It can, however, be wired for 115 V or 240 V operation.

U.S. Model: 115 V/60 Hz. To change the recorder from 60 to 50 (or 50 to 60) Hz operation, the motor pulley and motor capacitor must be changed, while motor and transformer must be rewired. We recommend that only

a Tandberg service station, representative or competent qualified technician perform this service. Power consumption maximum 45 W.

Note: Owing to the AUTOMATIC END STOP mechanism, the motor will not start before a tape is placed in the tape path.

Vertical installation

The tape recorder can be used in the horizontal or the vertical position. When used vertically it is necessary to attach feet to the front of the case, after removal of the two screws at the front of the case. In addition, the two rubber stops supplied must be attached over the two turntable spindles after the tape reels have been put on. This prevents the reels from falling off or being displaced while the recorder is in use. The rear panel supplied with the recorder is specially designed for vertical installation. This panel conceals all connections; it is very simple to fit. Insert it in the grooves and push it towards the deck plate.

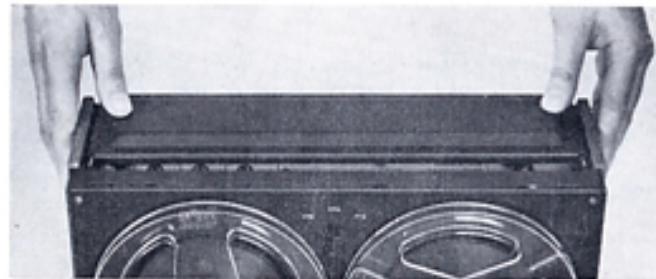

Preparation for use

Connect the mains cable to a socket providing the correct voltage and press the POWER button. The tape recorder is ready for immediate use. Place a reel of tape on the left hand turntable, ensuring that the reel runs anti-clockwise when the tape is drawn off.

Lay the tape in the tape path and place the free end in the hub slot of the empty reel on the right hand turntable. Set the operating lever in the FREE position. Both reels are now free to revolve independently of each other. Turn the right hand reel anti-clockwise until the tape is secure. Set the counter to zero.

Set the speed selector to the required speed. $7\frac{1}{2}$ ips gives the best sound quality while $1\frac{7}{8}$ ips gives the longest playing time. See technical specifications page 26.

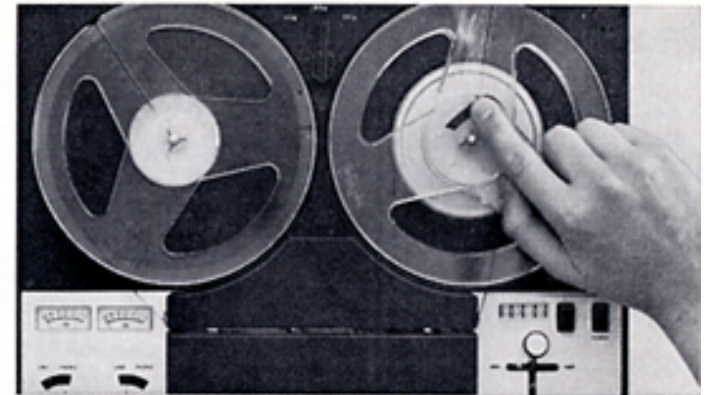

Inputs and outputs

Stereo receiver or amplifier

For stereophonic recording and playback through receiver or amplifier, connect a 5-pin DIN cable from the RADIO socket of the tape recorder to the TAPE output of the receiver or amplifier.

If the receiver or amplifier is fitted with phono sockets for recording and playback, connect as follows: For recording: two phono leads from LINE INPUTS L and R of the tape recorder to TAPE socket of the receiver or amplifier. For playback: connect two phono leads from OUTPUT L and R of the tape recorder to the respective inputs of the receiver or amplifier.



Headphones

The stereo jack marked HEADPHONES is intended for connection of stereo headphones. The headphone jack can be used for playback of programmes, for programme monitoring (AB-test) and for mixing different programmes. Use headphones with a minimum impedance of 200 ohms.



Copying tapes

Connect a cable fitted with 5-pin DIN plugs from the LINE output of the tape recorder on which the original tape is to be played, to the RADIO socket of the tape recorder which is to be used to make the copy. Alternatively, use phono leads from OUTPUTS L and R of the playing recorder to the respective LINE INPUTS L and R of the recording machine.

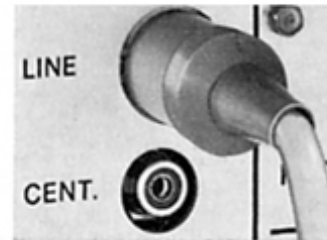

Record player

Any record player with a magnetic, ceramic or crystal pick-up can be connected to the DIN PHONO INPUT, or to PHONO INPUT L and R.

When a ceramic or crystal pick-up is to be used, the pick-up changeover button must be pressed, position C. If a magnetic pick-up is to be used, set the button to the outer position, M. The input amplifiers are then RIAA equalised.

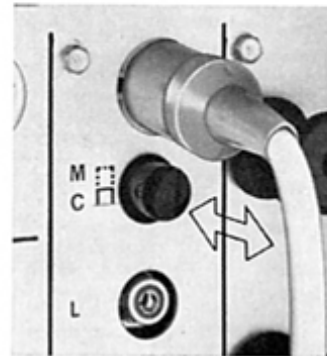

Centre channel

At the centre channel output, CENT, the programmes from both channels are mixed in playback. When playing back monaural programmes the CENT output provides the same programme as OUTPUT L or R. This output is for use in language studies, for monitoring and for mixing of programmes. Use headphones of at least 200 ohms impedance.

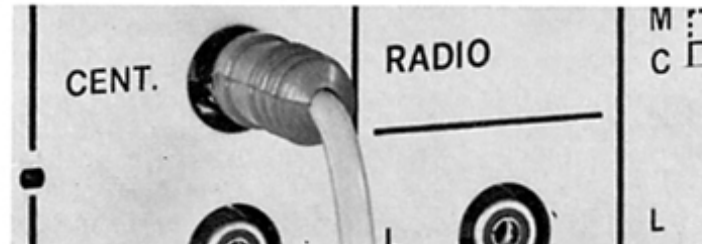

Microphone

For mono or stereo recording of live programmes, connect one or two microphones respectively to the inputs MIC L and R on the top deck.

For mono recording, the microphone amplifiers for channels L and R are connected in parallel. Thus you can record on either channel at will, irrespective of which channel the microphone is connected to.

For stereo recordings, place the microphone connected to MIC R to the right of the sound source, and the microphone connected to MIC L to the left of the sound source.

A wide range of sound levels may be experienced in



microphone recording. To prevent any distortion, depress the LIMIT button to switch the level limiter into circuit for each channel. See information about level limiter, page 16.

Mono recording

To record from a mono programme source, connect a phono lead from the DIODE or TAPE output of the programme source to LINE INPUT L or R of the tape recorder. If a DIN cable is used, connect it from the DIODE or TAPE output of the programme source to the RADIO socket of the tape recorder. Pins 1 and 4 of the DIN plug are used for recording.



Mono playback

To play back a mono recording, connect a phono lead from the tape recorder OUTPUT L or R to the respective TAPE IN L and R inputs of the receiver or amplifier. If a DIN cable is used, connect this from the tape recorder RADIO socket to the receiver or amplifier DIN socket TAPE. Pins 3 and 5 of the DIN plug are used for playback.



Mono recording

Connect the external equipment as described under «Inputs and Outputs» pages 6–8. Set the START/STOP button in the STOP position (not depressed). Select the programme from pickup or line input by means of the input selectors. Press RECORD L if the recording is to be made on the left hand (L) channel (RECORD R for the right hand channel) and hold it in while moving the operating lever to the → position.

The left hand or right hand indicator will now be illuminated.

Adjust the recording level of the channel in question by means of the RECORD LEVEL L or R knob. The upper RECORD LEVEL knobs control the microphone level while the lower knobs control the line or pick-up level, dependent upon the position of the input selectors. When recording mono, the input amplifiers for channels L and R are connected in parallel. Thus it is possible to record the programme on either channel at will, even though the programme input may be connected to the input for the other channel.

RECORD LEVEL knobs which are not in use during the recording should be set to zero. During recording the indicator needles should deflect up to the red sector.

For short periods of high signal level it is permissible for the indicator needle to deflect into the red sector. See also information about level limiter, page 16. To start recording, press the START/STOP button.

To interrupt or stop recording, release the START/STOP button.

The RECORD button is released when operating lever is returned to neutral.

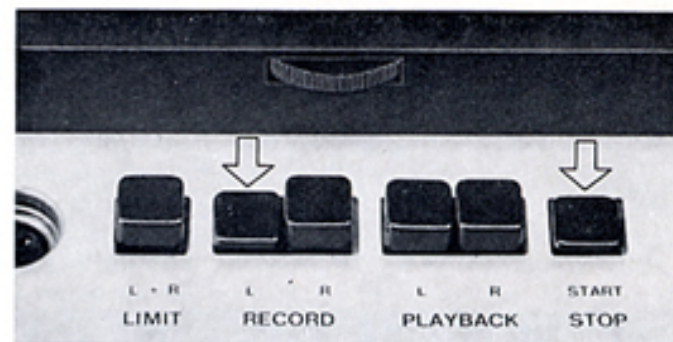

Stereo recording

Connect the programme source to the tape recorder as described under «Inputs and Outputs», pages 6–8. Procedure for stereo recording is the same as for mono, with the following exceptions:

The microphone levels are controlled by the upper knobs RECORD LEVEL L and R, while programmes from the line inputs or phono inputs are controlled by the lower knobs, RECORD LEVEL L and R.

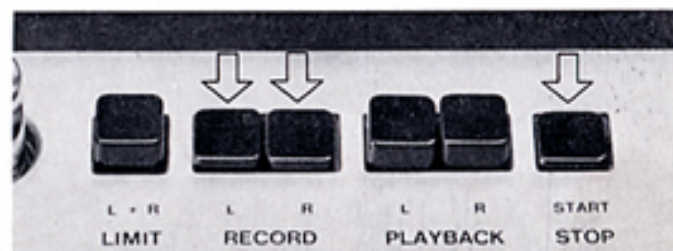

Set the START/STOP button in the STOP position (not depressed). Press the recording buttons RECORD L and R simultaneously while moving the operating lever to the → position.

Both indicators will now be illuminated. Adjust the recording levels so that the needles deflect up to the red sectors of the instruments. For short periods of high signal level it is permissible for the needles to deflect into the red sectors. See also information about level limiter, page 16. To start recording, press the START/STOP button.

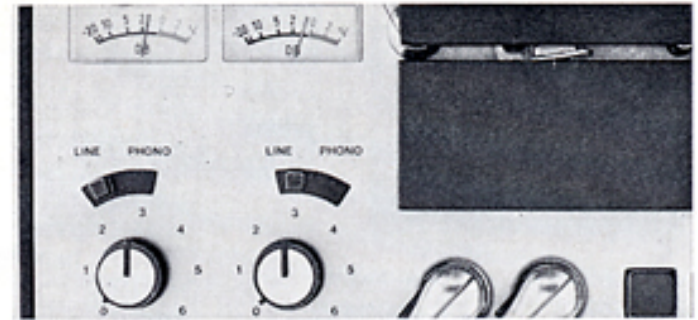

Programme monitoring during recording

The programme can be monitored in two ways while recording is in progress:

1. Before it is recorded on the tape (A-test).
2. After recording, through playback head and amplifier (B-test).

For programme monitoring, set the sound-on-sound switch to AB-TEST. Adjust the OUTPUT LEVEL for the channel in question to 6 (maximum) and connect headphones or amplifier and loudspeakers.



Mono: A-test when PLAYBACK L and R are not depressed. For B-test, press the PLAYBACK button for the required channel.



Stereo: A-test when PLAYBACK L and R are not depressed. For B-test press both buttons.

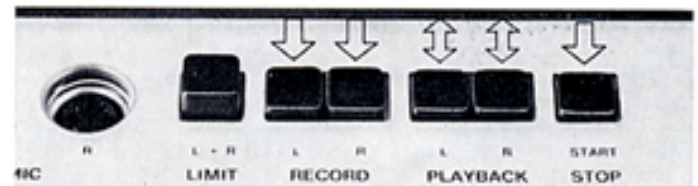

Mono playback

Connect receiver, amplifier or headphones as described under «Inputs and Outputs», pages 6–8. When using the fast forward or rewind, the counter or the cueing control can be used to locate the beginning of the desired programme. Check that the START/STOP button is not depressed. Set the sound-on-sound switch to the NORMAL or AB-TEST position. Press the PLAYBACK button for the required channel (L or R), set OUTPUT LEVEL L and/or R to 6 (maximum). Adjust loudspeaker volume by means of the receiver or amplifier controls.

Set the operating lever in the → position.

Commence playback by pressing the START/STOP button.

When playing back, the indicators will show the output level of the channels.

Programme output is fed to the outputs for each channel, OUTPUT L and R, RADIO pins 3 and 5, CENT and HEADPHONES.

After playback, set the operating lever to the neutral position.



Stereo playback

Connect external equipment as described under «Inputs and Outputs», pages 6–8. Set the sound-on-sound switch to the NORMAL or AB-TEST position. Press the PLAYBACK L and R buttons. Set the OUTPUT LEVEL L and R controls to position 6 (maximum). Set the operating lever in the → position.

Commence playback by pressing the START/STOP button.

The signals from the L and R channels are now fed to their respective outputs. The two channels are mixed at the CENT output.



Using the recorder as a pre-amplifier

The tape recorder can be used as a pre-amplifier for a receiver or external amplifier. Set the sound-on-sound switch to the AB-TEST position and the playback controls OUTPUT LEVEL L and R to position 6 (maximum). It is not necessary to have a tape in the tape path. Control the microphone level by means of the RECORD LEVEL knob.

Mono

Press one of the record buttons, RECORD L or R while moving the operating lever to the → position. If there is a tape in the path, set the START/STOP button in the STOP position. Programmes can be supplied to all the inputs for channels L and R. After use, set the operating lever to the neutral position.

Stereo

When the record and playback buttons are unoperated, the tape recorder acts as a stereo pre-amplifier. The channels are now separated so that a programme amplified through channel L is fed to the L outputs and a programme amplified through channel R is fed to the R outputs.

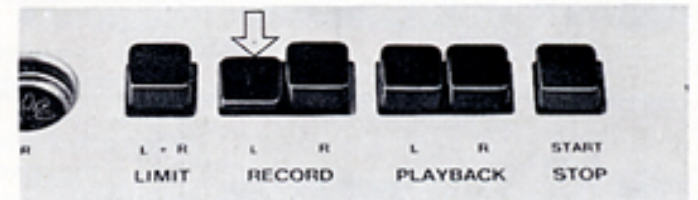

Sound-on-Sound

A-test

Sound-on-sound is a technique by which a programme can be played back from one channel and transferred by internal connections in the tape recorder to the recording amplifier for the other channel. The programme being played back can be monitored by means of headphones while, for example, using a microphone to record a second voice to a song, or to comment upon the programme. The microphone programme mixes with the programme being played back, and is recorded on the other channel.



Set the sound-on-sound switch to the S ON S position. Suppose that a programme has been recorded on channel L. The position of the control buttons is shown in the sketch. The programme played back from channel L is automatically connected to the input of channel R and can be adjusted by means of the lower RECORD LEVEL R. The recording level for the programme fed in from line or microphone can be adjusted by means of the relevant RECORD LEVEL knob. For the sound-on-sound operation, programmes can be fed in to all inputs except LINE INPUT R, RADIO pin 4, PHONO DIN pin 1 or 5, or PHONO R. These are disabled when the sound-on-sound switch is in the S ON S position. Connect headphones to OUTPUT R.

The level of the mixed signal is indicated on the right hand instrument. After completion of a sound-on-sound recording, rewind the tape and play back in mono through channel R.

Set the sound-on-sound switch to the NORMAL position. If the pre-recorded programme is on channel R, produce sound-on-sound as described above, but press buttons RECORD L and PLAYBACK R and connect the headphones to OUTPUT L.

AB-test

For B-test the same applies as for A-test, except that in addition the playback button for the recording channel must be pressed. To ensure quality recordings with B-test, two people are required. The person singing or playing a programme listens to the pre-recorded programme with the headphones connected to OUTPUT L. The person monitoring the programme listens to it after mixing and recording on the tape, B-test. The headphones are connected to OUTPUT R. By operating the PLAYBACK R button, the programme can be A-tested to ensure that there is no difference in quality between the A- and B-test. Input level and mixing of the programmes are controlled by the monitoring person.

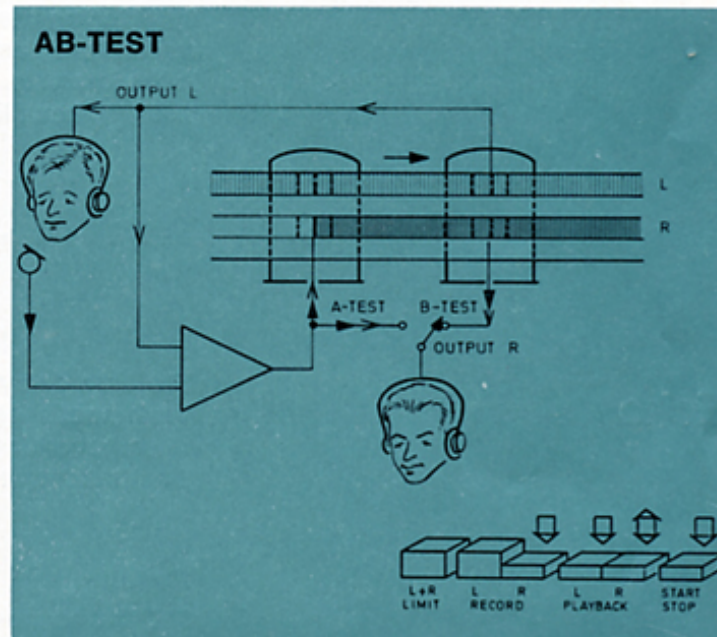
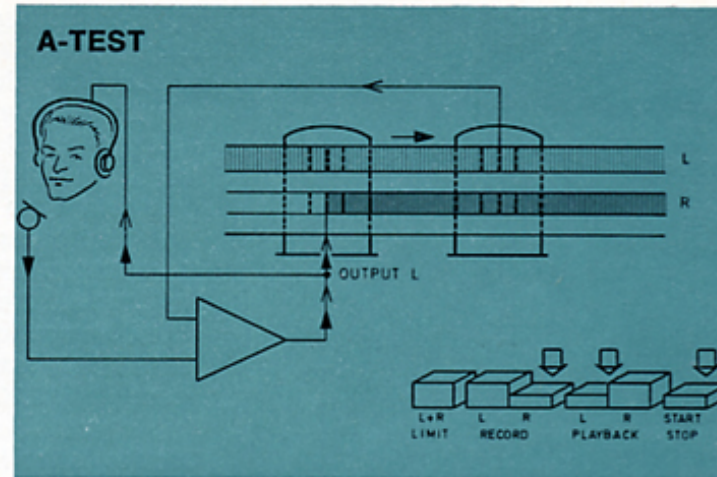

Add-a-Track

Add-a-track is a technique by which a programme is played back from one channel while a new programme is being recorded on the other channel. When the tape is subsequently played back in stereo, both programmes are heard simultaneously. This is useful, for example, in language studies, where the master programme on the one channel can be played back while the student response is recorded on the other channel. Connect the microphone to one of the inputs MIC L and R. Connect the headphone (mono) to CENT. Set the sound-on-sound switch to S ON S. Suppose that the master programme has been recorded on channel L. Press PLAYBACK L and RECORD R and set the operating lever to →.

Set the lower RECORD LEVEL R knob to zero. Adjust the recording level by means of the relevant RECORD LEVEL knob. Adjust the headphone level by means of OUTPUT LEVEL L and R. Start playback and recording by pressing the START/STOP button. Now listen to the master programme and repeat the words and phrases in the intervals. When the programme is finished, rewind and play back in stereo.

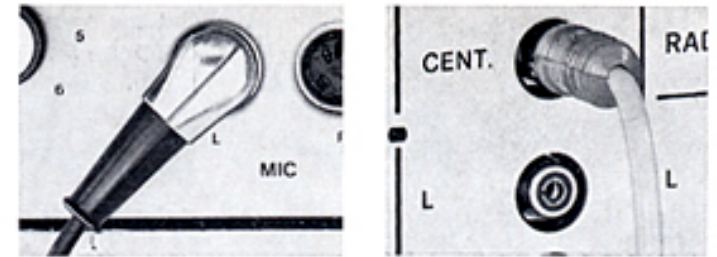

Echo

The time delay between the separate record and playback heads can be utilized to produce echo effects when recording in mono or stereo. The reverberation time is longest at the lowest tape speed.

Mono

Set the sound-on-sound switch to the NORMAL position. Connect a phono lead from OUTPUT L or R to LINE INPUT L or R. Set the input selector for the channel receiving the returned signal to LINE. Set the OUTPUT LEVEL knob for the playback channel to po-

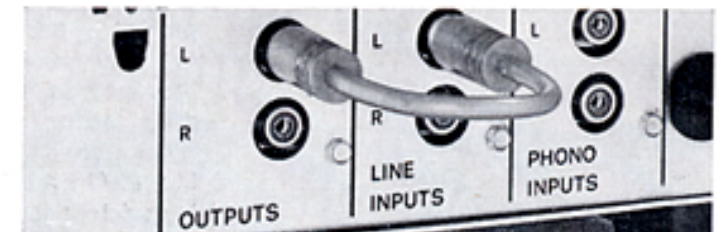

sition 6 (maximum). Connect one or two microphones to MIC L and/or R, and adjust the microphone level by means of the relevant RECORD LEVEL knob. Adjust the

input level of the returned signal by means of the lower RECORD LEVEL L or R knob.

Echo effects can also be produced on programmes fed to the line or phono input for the channel not receiving the returned signal. Set the input selector for this channel to LINE or PHONO, depending on the programme source. Press the recording and playback buttons for the same channel and move the operating lever to →. The indicator for the recording channel will now be illuminated.

When recording from a microphone, speak into to microphone and adjust the level to give the correct indicator needle deflection. Start recording by pressing the START/STOP button. Carefully turn up the lower RECORD LEVEL knob for the channel receiving the returned signal. The increasing echo effect passing to the tape can be monitored by means of the headphones or loudspeaker.

NB: Do not turn up the lower RECORD LEVEL knob so high that the echo becomes distorted.

Stereo

For echo effects in stereo follow the same procedure as for mono, with the following exceptions:

Connect two microphones to the tape recorder and connect phono leads from OUTPUTS L and R to their respective LINE INPUTS L and R. Connect the headphones to the HEADPHONES output. Set the input selectors to the LINE position. Adjust OUTPUT LEVEL L and R to position 6 (maximum). Adjust the level of returned signals by means of the lower RECORD LEVEL L and R knobs. Only the microphone inputs can be used for stereo echo.

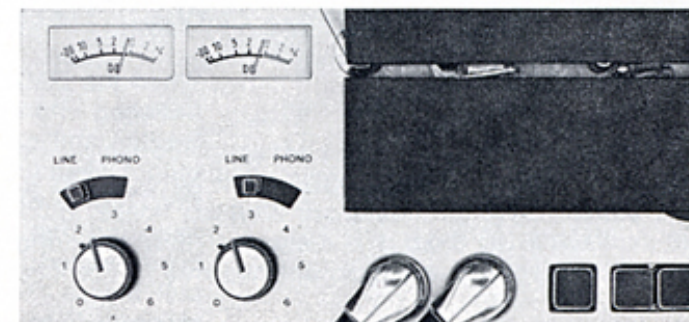
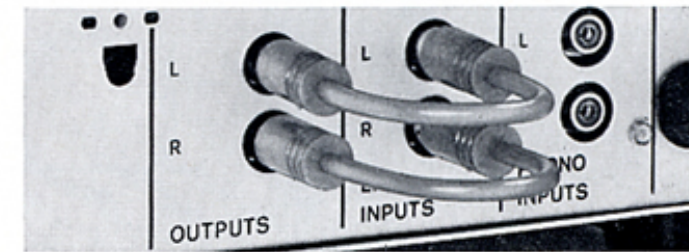
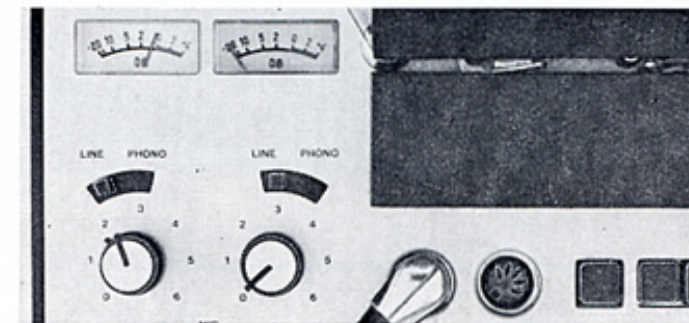

Mixing

Mono recording

When producing mono recordings it is possible to mix as many as 4 different programme sources: Two microphone programmes (MIC L and R), which are controlled by the upper RECORD LEVEL L and R knobs, and programmes fed to the line inputs (LINE INPUTS L and R or RADIO pins 1 and 4). The line programmes are controlled by the lower RECORD LEVEL L and R knobs. When the input selectors are set to the PHONO position, the line inputs are disconnected and the pick-up inputs PHONO L and R or the DIN plug pins 3 and 5 can be mixed with the microphone programme. The desired mixing ratio of the programmes can be monitored and controlled by means of external speaker or headphones. If one input selector is set for LINE and the other for PHONO, it is possible to mix microphone programmes with line programmes from one channel and phono programmes from the other channel.

Stereo recording

When recording in stereo it is possible to mix two programmes on each channel. One programme is fed to the microphone input (MIC) while the other is fed to the line input (LINE INPUT or RADIO) or to the pick-up input (PHONO): Selection of line and pick-up input is effected by means of the input selector. The upper RECORD LEVEL knobs control the microphone levels while the lower knobs control the levels from line or phono inputs.

Mono pre-amplifier

When the tape recorder is being used as a mono pre-amplifier, it is possible to perform the same mixing operations as for mono recording.

Stereo pre-amplifier

When the tape recorder is being used as a stereo pre-amplifier, it is possible to perform the same mixing operations as for stereo recording.

Level limiter

When the LIMIT button is depressed, a level limiter is switched into circuit in each channel, to prevent overloading and consequent distortion of recordings or of output when the tape recorder is in use as a pre-amplifier. The level limiter should be used whenever it is expected that the average programme input level may be exceeded. The limiter should be switched into circuit before recording commences or before the tape recorder is to be used as a pre-amplifier.

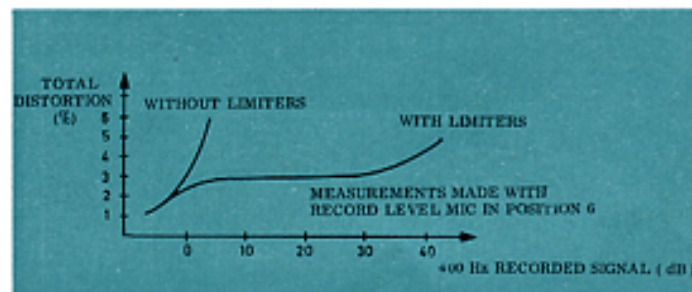

It is important to set the RECORD LEVEL controls to the optimum levels before using the level limiters, in order to avoid the limiters operating too high in the control range. This would cause a reduction of the dynamic range of the programme.

The recorded programme will be distortion-free and will have optimum signal/noise ratio.

If the limiters are in circuit, it is possible to record signals which come close to the pain level of the human ear (120 dB), without distortion and independently of the position of the recording controls.

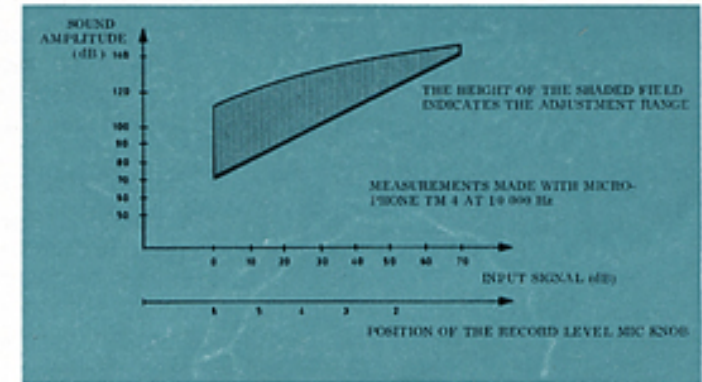

Sound-on-Sound switch

The sound-on-sound switch has 3 positions: NORMAL, AB-TEST and S ON S.

NORMAL:

In the NORMAL position the switch breaks the connection between the recording and playback amplifiers for the same channel. This allows only a B-test of the programme, mono or stereo. When playing back mono programmes the programme is fed to both outputs.

AB-TEST:

In the AB-TEST position the switch connects the recording and playback amplifiers for the same channel. This allows a choice of A- or B-test, mono or stereo. In mono playback the programme is fed to both outputs.

S ON S:

S ON S connects the recording and playback amplifiers for the same channel. This allows a choice of A- or B-test, mono or stereo. In the sound-on-sound position

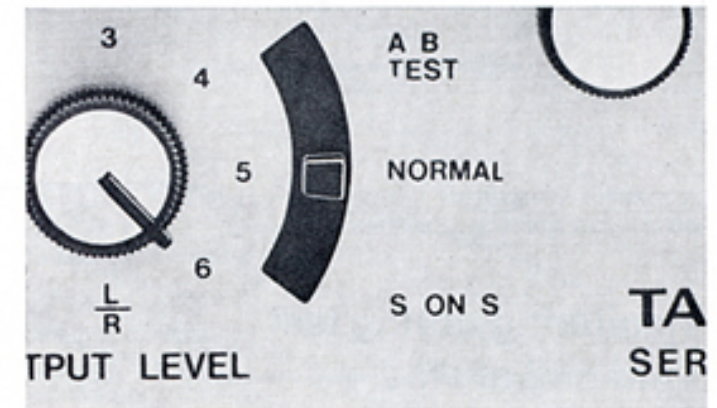

the switch connects the programme which it is desired to overlay to the RECORD LEVEL R control, lower knob, which controls the recording level of this programme. When the switch is in the S ON S position, the connection between the playback channels is broken.

FM-MX-filter

The Tandberg FM-MX filter is especially designed for use with Tandberg stereo tape recorders. The active FM-MX-filter requires operating power (+26 V). The filter should be used if troublesome howl or whistle is experienced when recording FM-stereo broadcasts.

Connecting the FM-MX filter

Connect the filter DIN plug to the tape recorder RADIO socket and connect the red special plug to the output marked +26 V. Connect a DIN cable from the receiver DIODE or TAPE output to the RADIO input of the FM-MX filter. If the receiver is fitted with phono output, connect two phono leads from the receiver DIODE or TAPE outputs to the FILTER INPUT L and R of the FM-MX filter. Instead of using the filter DIN cable, phono leads can be used to connect the phono FILTER INPUT to the tape recorder phono LINE INPUTS L and R. Connect the red special plug to output +26 V.



Monitoring during fast wind and rewind - cueing

When using the fast forward and reverse tape wind, the monitoring and cueing control can be used to press the tape against the playback head. The PLAYBACK button for the channel to be monitored must be pressed. Monitoring is effected through an external amplifier and speaker or through headphones connected to the tape recorder. Owing to the high winding speed, the sound will change character, but it is sufficiently recognisable to permit location of programmes and starting points for further recording.



4-track recording and playback

This section applies only to the 4-track version of Series 6000 X.

Recording

Programmes can be recorded on four separate tracks. Each track covers almost a quarter of the tape width. All programmes are recorded on the same side of the tape, i.e. the dull side. For practical reasons, however, the text refers to sides 1 and 2 of the tape, side 1 being defined as tracks 1 and 3 while side 2 is defined as tracks 2 and 4.

Recording on channel L, with the RECORD L button depressed, records the programme on tape track 1. When the whole length of the tape has been recorded, interchange and turn over the tape reels so that side 2 comes up. Continuing to record on channel L, with the RECORD L button depressed, records the programme on track 4. When the track is full, turn over the tape reels again so that side 1 comes up. The next programme must be recorded on track 3, and RECORD R must therefore be depressed. When track 3 has been filled, turn the tape over yet again so that side 2 comes up, and record on track 2, with RECORD R depressed.

Playback

For mono playback it is possible to choose between programmes from tracks 1 and 3 by pressing buttons

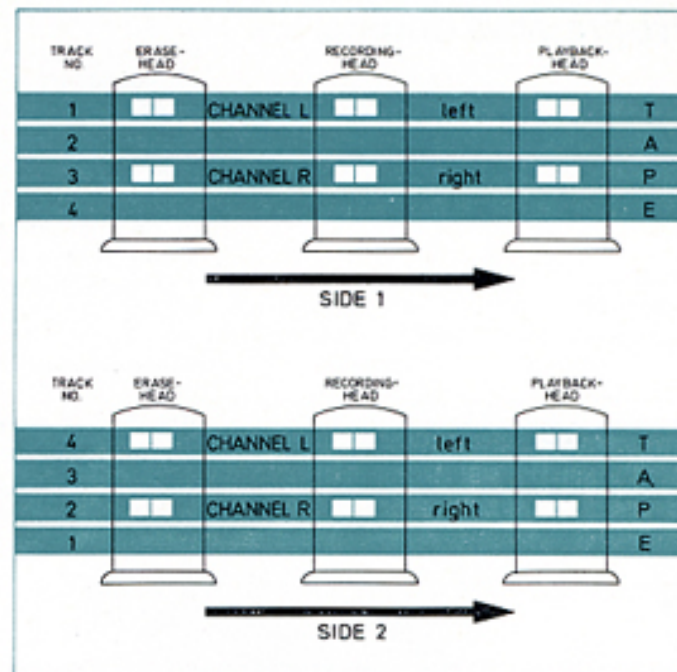

PLAYBACK L or R respectively. Turning over the tape so that side 2 comes up, similarly offers a choice between tracks 4 and 2.

Automatic stop

Series 6000 X is fitted with a switch which automatically stops the motor and the turntables when the tape is finished or if it breaks. The sensor which controls the switch is located in the tape path near the right hand

guide post. The automatic stopping mechanism also prevents the motor from starting before a tape has been laid in the path. If the tape has been incorrectly inserted the recorder will not start.

Programme editing

Programmes are not always recorded in the same sequence as they are required for playback. It may therefore be necessary to edit tapes, i.e. cut and splice them so as to present the programmes in the desired sequence. When a cutting point has been located during playback, stop the tape instantaneously by means of the START/STOP button. Take hold of the tape at the right hand guide post and pull it out to the right hand edge of the mains switch POWER.

The operating lever must be in the → position.

The point at which the tape is to be cut (see «Tape

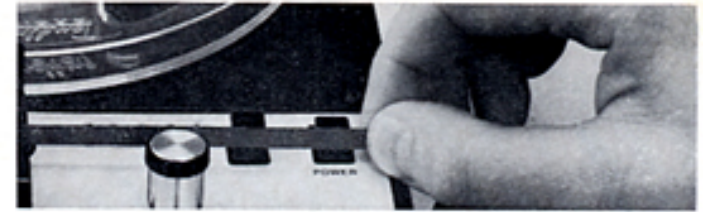

splicing», below) is now at the right hand post, the point from which the tape was pulled.

Tape splicing

For editing purposes, or if the tape has snapped, the ends must be spliced.

Lay the ends of the tape over each other with the same side of the tape facing upwards.



Cut the tape with scissors or a knife (non-magnetic) at an angle of about 45°. Lay the tape ends against each other, shiny side up. Lay the splicing tape across the join, parallel to the cut, and press firmly, squeezing out any air bubbles.



Cut off the splicing tape at both edges, cutting in a slight curve into the edge of the recording tape. This will prevent adhesive from the splicing tape from being deposited on the magnetic heads.



Note: Adhesive tape which is not expressly intended for splicing recording tapes must under no circumstances be used.

Electrical remote control of start and stop

Series 6000 X can be started and stopped instantaneously by means of external pedal equipment which can be connected to the FOOT CONTROL TFC 2 input, pins 1 and 3. When the pedal is used, the START/STOP but-

ton must not be depressed. The tape recorder starts when the pedal is depressed and stops when it is released.

Erasing

When a new programme is recorded on one or two tracks (mono or stereo), the existing programmes on these tracks are automatically erased simultaneously with recording. If it is desired to erase a programme

without making a new recording, this can be effected by running the tape through the recorder in the record position, with the RECORD LEVEL knobs set to zero.

Cleaning heads and tape path

The heads, capstan and guide posts should be cleaned at regular intervals since certain types of tape leave deposits on these parts. For this reason it is also important to use good quality tapes. Deposits will cause a reduction of the signal/noise ratio and poor treble reproduction. Dirt on the magnetic heads also causes drop-outs. If you notice any of these symptoms it is time to clean heads, capstan and guide posts. The procedure is as follows: Remove the front and back covers by first depressing springloaded buttons and then releasing covers and lifting as indicated on fig. Wrap a piece of flannel cloth round a small stick and moisten with pure alcohol. Acetone or trichlorethylene must not be used, since this may damage heads. Clean the heads, guide posts and capstan. Replace the covers by inserting in retaining brackets and pressing into position.



Note: The head adjusting screws must not be touched.

Carrying case

Carrying case model 5 is an attractive, practical and rugged transport case for tape recorder 6000 X in cassette. The front of the tape recorder should point at the side of the case marked FRONT. The case is fitted with locks. It weighs 5 lbs. (2,3 kilos).



Microphone TM 5

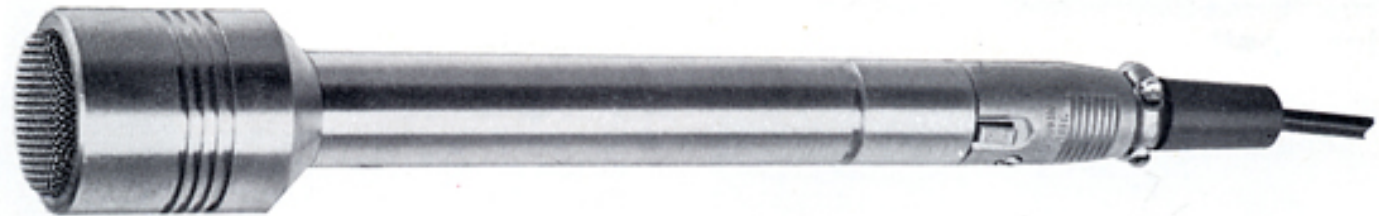

Tandberg TM 5 is a dynamic microphone of high sensitivity, spherical characteristic and low sensitivity to contact sounds and blowing noises. The microphone is manufactured especially for use with Tandberg tape recorders. The housing is of metal and is fitted with a plug for connecting a microphone lead socket.

Technical specifications:

Frequency range: ± 3 dB 90–13 000 Hz.
Sensitivity at 1000 Hz: 0,2 mV/ μ bar.
Impedance: 600 ohms.
Length: 6 $\frac{1}{2}$ " (165 mm.)
Diameter: 1 $\frac{11}{32}$ " (34 mm.)

Connecting plugs

Wiring diagrams for the plugs to be connected to the DIN outputs MIC L and R, LINE, RADIO, PHONO and stereo jack HEADPHONES, and the special input for FOOT CONTROL TFC 2.

NB: The plugs are seen from the wiring side.

MIC

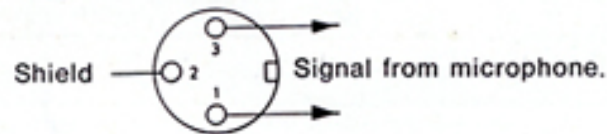

HEADPHONES

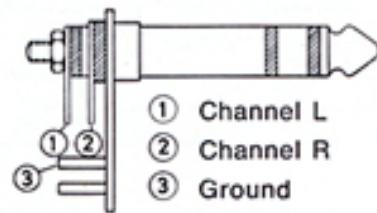

PHONO

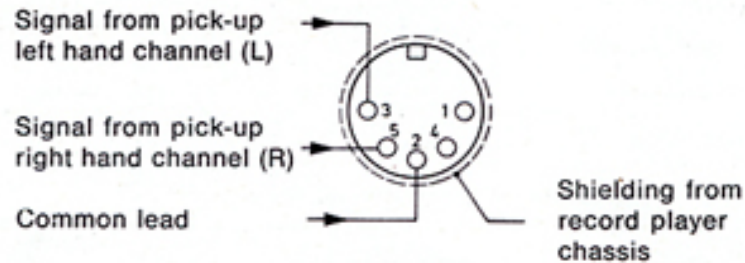

The common lead must not be connected to the shielding. Pins 1 and 5 are connected together within the plug.

LINE

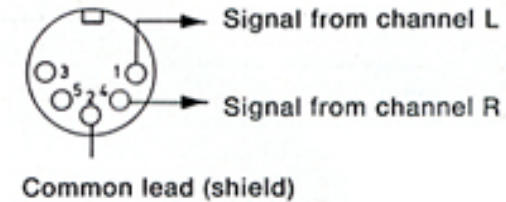

RADIO

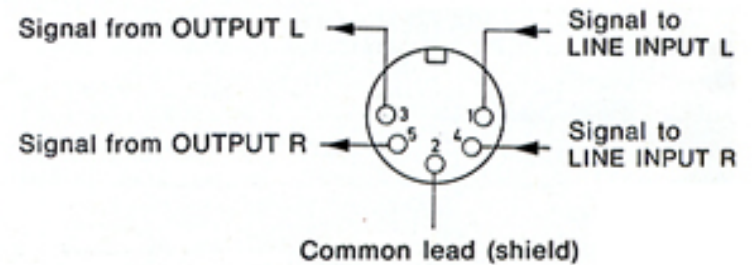

FOOT CONTROL TFC 2

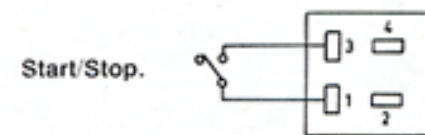

Pin 4 is grounded while pins 1 and 2 are connected in the tape recorder.

Function table

Use of Model 6000 X	Position of buttons				
Function	Function buttons		Sound on Sound switch	Programme at outputs	Remarks.
	Channel L	Channel R			
Mono record/playback			Normal	Recorded programme fed to both outputs via tape (playback).	If the playback button for the recording channel is unoperated, no programme is fed to the outputs.
Mono record with monitoring			AB-test	Same programme to both outputs	A test: playback button unoperated. B test: playback button depressed.
Stereo record/playback			Normal	Recorded programme fed to respective outputs via tape (stereo playback)	If the playback buttons are unoperated, no programme is fed to the outputs.
Stereo record with monitoring			AB-test	Stereo programme (channels separated)	A-test: playback buttons unoperated. B-test: playback buttons depressed.
Mono playback			Normal	Same programme at both outputs	
Stereo playback			Normal	Stereo programme (channels separated)	
Mono pre-amplifier			AB-test	Same programme at both outputs	Operating lever in → position with or without tape in tape path.
Stereo pre-amplifier			AB-test	Stereo programme (channels separated)	
Sound-on-Sound			S on S	In the examples chosen under -remarks-: Output L only gives L programme, output R gives the mixed programme in A-test or B-test dependent on button Playback R. Output level L does not affect S on S function but controls sound level at L output.	Example: Transfer from channel L to channel R. With headphones connected to output L listen only to played-back programme. With headphones connected to channel R listen to the played-back programme and the mixed programme in A-test when channel R is A-test. Channel R can also give B-test (owing to time lag the artist cannot listen to B-test). For transfer from channel R to channel L procedure is reversed.
			S on S		
Add-a-track			S on S	Played back programme to L and R outputs. Input programme fed via recording channel output. Both programmes to centre channel.	Always set Record Level Line/Phono for channel R to zero. If the two programmes are to be synchronised, use sound on sound function.
Mono echo			Normal	Same echo programme at both outputs	For recording and playback e.g. on channel L, connect L output to R input. Echo level is controlled by Line Record Level R.
Stereo echo			Normal	Stereo echo (channels separated)	For stereo echo, only microphones can be used.
Mono mixing during recording with monitoring			Ab-test	Mixed programme at both outputs	4 different programmes can be mixed: A-test: playback buttons unoperated. B-test: playback buttons depressed.
Stereo mixing during recording with monitoring			AB-test	Mixed stereo programme (channels separated)	2 programmes per channel can be mixed: A-test: playback buttons unoperated. B-test: playback buttons depressed.

Block diagram Series 6000 X

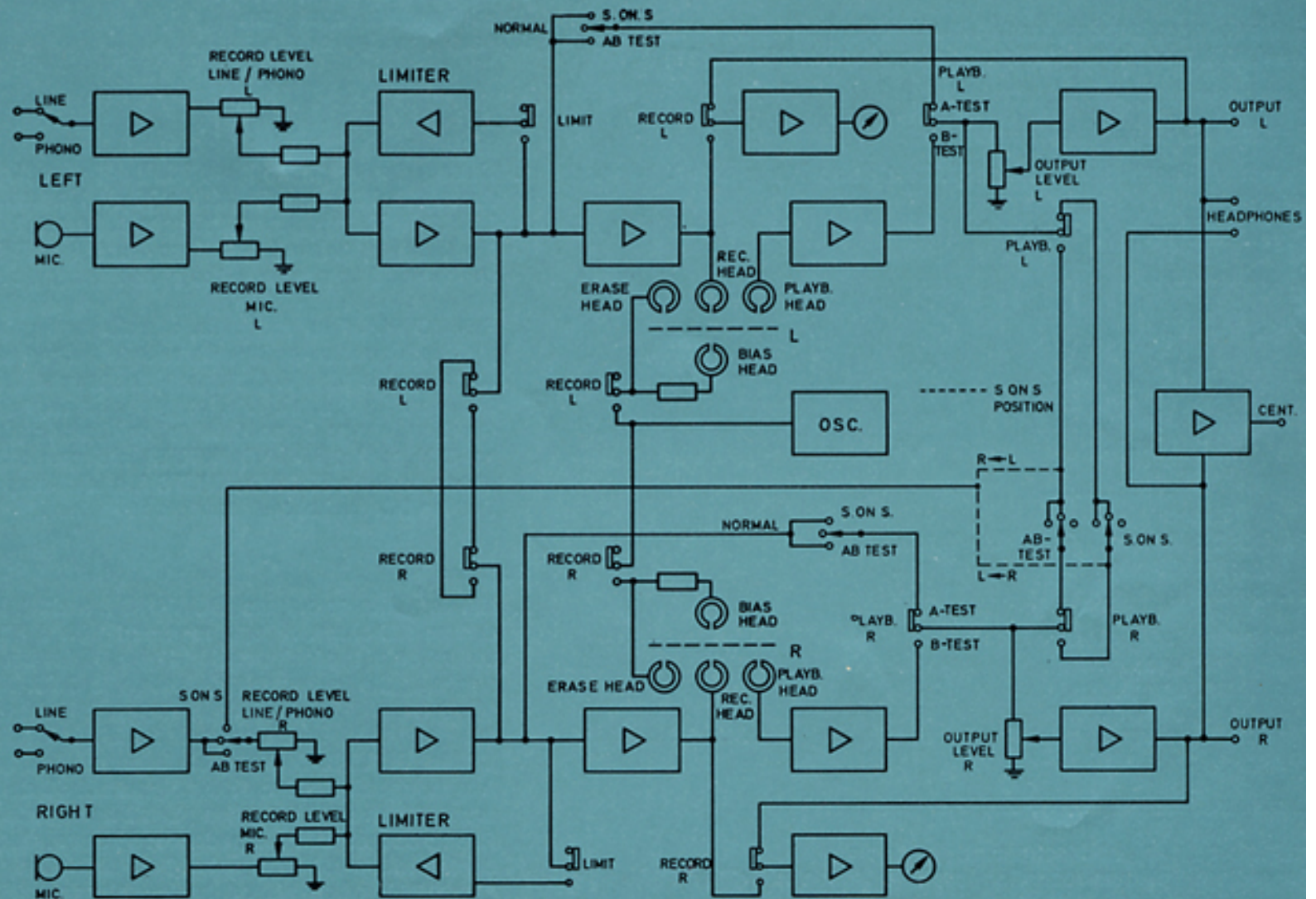

The function selectors are illustrated in the inoperative position (not depressed). The sound-on-sound switch is in the NORMAL position.

Technical specifications:

Mains voltage: Standard model: 230 V/50 Hz. Can be wired for 115 and 240 V. U.S. model: 115 V/60 Hz. Can be wired for 230 and 240 V.

Power consumption: Maximum 45 watts.

Motor: Hysteresis synchronous motor.

Tapes: Maximum reel diameter 7". Low Noise Tapes should be used for recordings.

Tape speed: 7¹/₂, 3³/₄, 1⁷/₈ ips.

Speed tolerance: 1 %.

Playing times:

1200 ft. tapes		
	Stereo	Mono
7 ¹ / ₂ ips:	2 x 32 min.	4 x 32 min.
3 ³ / ₄ ips:	2 x 64 min.	4 x 64 min.
1 ⁷ / ₈ ips:	2 x 128 min.	4 x 128 min.

1800 ft. tapes		
	Stereo	Mono
7 ¹ / ₂ ips:	2 x 48 min.	4 x 48 min.
3 ³ / ₄ ips:	2 x 96 min.	4 x 96 min.
1 ⁷ / ₈ ips:	2 x 192 min.	4 x 192 min.

Fast forward and reverse wind:

For 1200 ft. tape: 1³/₄ min.

For 1800 ft. tape: 2¹/₂ min.

Heads: Erase head, recording head, playback head and bias head (Tandberg Cross-Field).

Erase and bias frequency: 85.5 kHz. Distortion less than 0.5 %.

Indicator: Moving coil instrument.

Recording: Optimum recording level: Deflection to 0 dB and 3 % tape distortion.

Playback: Instrument indicates output level of relevant channel.

See «Outputs» under Technical specifications.

Level limiter: With the limiters in circuit and the input controls at maximum, limiting range is better than 30 dB. This range is somewhat

reduced, however, when the input controls are turned down, see under «Level Limiter», page 16.

Attack time: Maximum 5 ms.

Release time: Approx. 1 s.

Inputs:

Each channel has the following inputs:

1. Balanced microphone input (MIC) for dynamic microphone, impedance 200–700 ohms. Sensitivity 70 μ V. Maximum input level: 70 mV.
2. LINE INPUT. Impedance: 100 kohms. Sensitivity: 5 mV. Maximum input level: 15 V. Pins 1 and 4 on DIN socket RADIO are connected in parallel with the phono terminals LINE INPUTS L and R respectively.
3. PHONO INPUT for magnetic, ceramic or crystal pick-up. Magnetic pick-up; impedance: 33 kohms. Sensitivity: 1 mV at 1000 Hz. Maximum input level: 3 V. Ceramic pick-up; sensitivity 10 mV at 1000 Hz. Maximum input level: 30 V. Impedance matched for ceramic pick-up. Crystal pick-up: Same data as for ceramic pick-up. Pins 3 and 5 on DIN socket PHONO INPUTS are connected in parallel with phono sockets PHONO INPUTS L and R respectively. Pins 1 and 5 of the DIN socket are connected together.

Outputs:

1. Emitter follower outputs (OUTPUTS L and R). Minimum load impedance: 200 ohms. A tape recorded with a 400 Hz signal at 0 dB deflection of the instrument will give 1.5 V when played back. During playback the instrument deflection is 0 dB. Phono sockets OUTPUTS L and R are connected in parallel with their respective contacts on the stereo jack marked HEADPHONES.
2. LINE OUTPUTS. DIN socket. Impedance: 5 kohms. Output level: A tape recorded with a 400 Hz signal at 0 dB deflection of the instrument will give 160 mV when played back (unloaded).
3. RADIO socket (DIN). Impedance: 5 kohms. Output level: A tape recorded with a 400 Hz signal at 0 dB deflection of the instrument will give 0.75 V when played back (unloaded). Pins 3 and 5 of the RADIO socket are connected to channels L and R respectively.
4. Stereo headphone output (HEADPHONES). Stereo jack. Minimum load impedance: 200 ohms per channel. Output level: A tape recorded with a 400 Hz signal at 0 dB deflection of the instrument will give 1.5 V when played back (unloaded).

5. Centre channel output (CENT). Phono socket. Minimum load impedance 200 ohms. Output level. A tape recorded with a 400 Hz signal at 0 dB deflection of the instrument will give 1.5 V when played back.

For playback under points 1–5, OUTPUT LEVEL controls were set to maximum, position 6.

Distortion: Distortion in recording amplifier: Recording of a 400 Hz signal at 0 dB level, gives less than 0.5 % distortion from the recording amplifier.

Distortion in playback amplifier: 0.3 % at 1.5 V output voltage.

Tape distortion: A tape recorded with a 400 Hz signal at 0 dB level, gives less than 3 % tape distortion in playback.

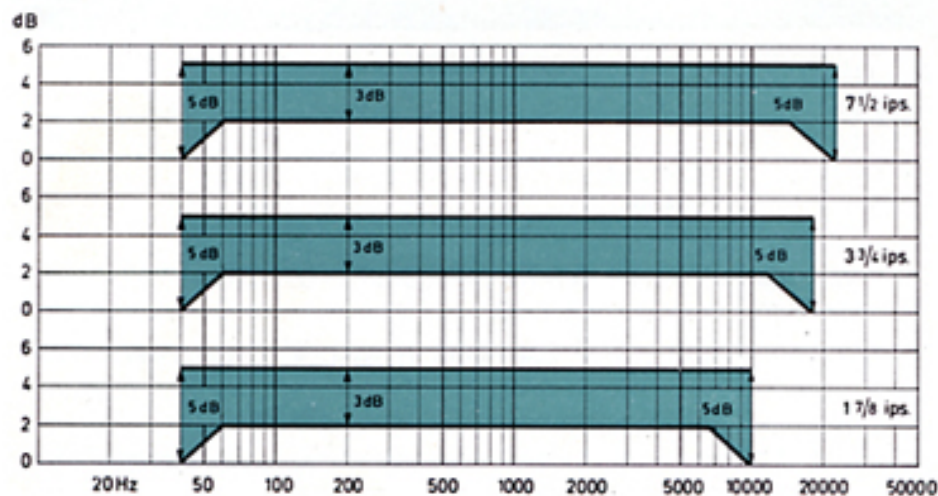

The coloured sectors, valid for this model, indicate tolerance areas for total frequency response measured according to DIN 45511.

Frequency response:

Referred to 400 Hz.

Measured to DIN 45511

7 1/2 ips: 40–20 000 Hz. ± 2 dB

7 1/2 ips: 40–22 000 Hz.

3 3/4 ips: 50–16 000 Hz. ± 2 dB

3 3/4 ips: 40–18 000 Hz.

1 7/8 ips: 50–9 000 Hz. ± 2 dB

1 7/8 ips: 40–10 000 Hz.

In amplifier position: 30–18 000 Hz. ± 3 dB.

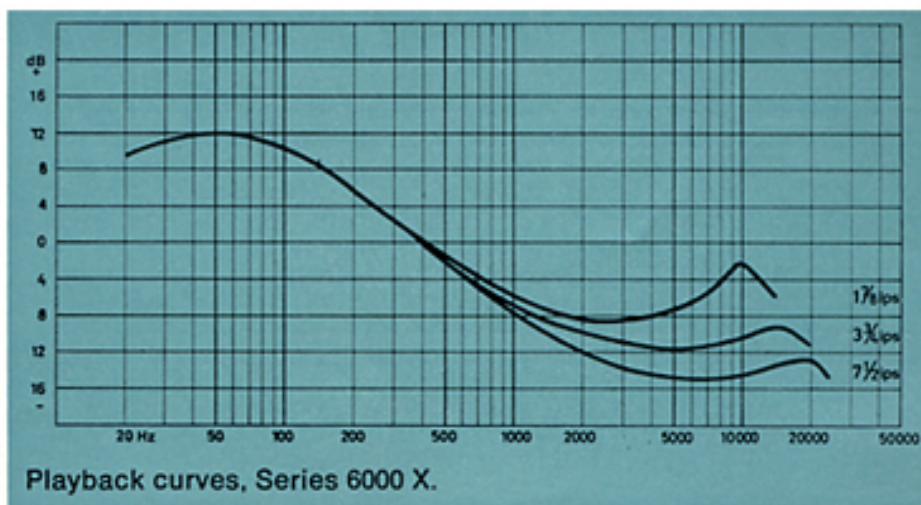
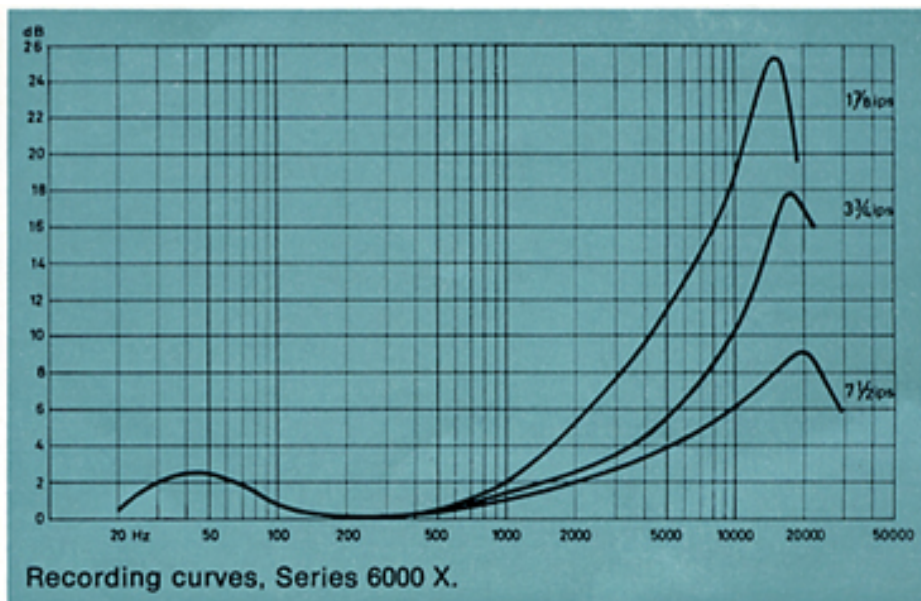

Wow:

Wow measured R.M.S.

7¹/₂ ips: 0.07 ‰3³/₄ ips: 0.14 ‰1⁷/₈ ips: 0.28 ‰

Measured to DIN 45511

7¹/₂ ips: 0.1 ‰3³/₄ ips: 0.2 ‰1⁷/₈ ips: 0.4 ‰**Signal/tape noise, weighted (Geräuschspannung):**Peak value measured to DIN 45511 at tape speed 7¹/₂ ips and 5 ‰ tape distortion.

4-track	2-track
56 dB	58 dB

Signal/tape noise, weighted (IEC A-curve) R.M.S.:Tape speed 7¹/₂ ips, 5 ‰ tape distortion

4-track	2-track
64 dB	66 dB

Signal/tape noise:Linear measurement to IEC, 5 ‰ distortion and tape speed 7¹/₂ ips.

4-track	2-track
58 dB	58 dB

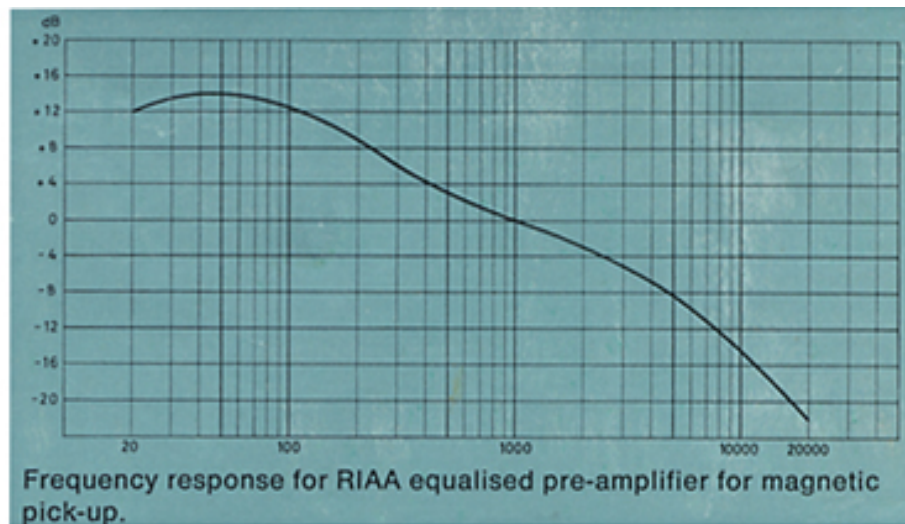
**Signal/tape noise, linear (Fremdspannung):**Peak value measured to DIN 45511 at tape speed 7¹/₂ ips and 5 ‰ distortion.

4-track	2-track
54 dB	54 dB

Crosstalk suppression:

Crosstalk suppression at 1000 Hz, measured to DIN 45511.

Mono >60 dB Stereo >50 dB.

Dimensions: Length: 15¹/₂" (39.4 cm). Height: 6¹/₂" (16.5 cm). Depth: 12³/₈" (31.6 cm).**Weight:** 20 lbs. (9.5 kilos.).**TANDBERGS RADIOFABRIKK A/S****Kjelsåsveien 161 – Oslo****DEALER:**

Tandbergs Radiofabrikk A/S, Kjelsås. Tandbergs Radiofabrikk A/S, Kjeller.